

Monitoring H₂
by Real Time H₂ sensor
Nohmi, T.¹ and Mogi, T.²

¹ HySafeNohmi, 7-2 Gyoda, Gyoda, Saitama, 361-0073, Japan, nohmi@nohmi.tokyo

² Graduate School of Engineering, The University of Tokyo, 7-3-1 Hongo, Bunkyo-ku, Tokyo, 113-8656, Japan, mogi.toshio@mail.u-tokyo.ac.jp

Abstract:

Portable H₂ sensor was made by using mass spectrometer for the outside monitoring experiment: the leak test, the replacement test of gas pipe line, the combustion test, the explosion experiment, the H₂ diffusion experiment and the recent issue of the exhaust gas of Fuel Cell Vehicle. In order to check the real time concentration of H₂ in various conditions, even in the highly humid condition, the system volume of the sampling route was minimized with attaching the humidifier. Also to calibrate H₂ concentration automatically, the specific concentration H₂ small cylinder was mounted in the system. In the experiment, when H₂ gas was introduced in the N₂ flow or air in the tube or the high-pressure bottle, highly concentrated H₂ phases were observed by this sensor without diffusion. This H₂ sensor can provide the real time information of the hydrogen molecules and the clouds. The basic characterization of this sensor showed 0-100% H₂ concentrations within 2ms. Our observation showed the size of the high concentration phase of H₂ and the low concentration phase after mixing process. The mixed and unmixed H₂, unintended concentration of cloud gas, the high speed small cluster of hydrogen molecules in purged gas were explored by this real time monitoring system.

1. Introduction

We are on the way of 2020 Tokyo Olympic Games and under the words of clean energy, the hydrogen energy applications are prospectively been developed: in Fuel Cell Vehicle (FCV), the cogeneration type of Fuel Cell for domestic applications and, the combustion of biogas in electric power generation plant etc. But hydrogen is a small molecule with lightweight. Leak may occur from hydrogen base systems through O-ring seals and vent in building or storage facilities containing hydrogen. The leaked hydrogen or the unintended concentration of hydrogen as a cloud should be detected as soon as detected for the safety sake[2,3,4]. In order to detect very low concentration of H₂ cloud in real time at the same time other gases, Mass spectrometer system with differential pumping stages [7] are developed and H₂/N₂ mixing experiment are carried out in real time.

Agreement concerning the establishing of global technical regulations for wheeled vehicles, equipment and parts which can be fitted and/or be used on wheeled vehicles is mostly solidified. According to the Global technical regulation on hydrogen and fuel cell vehicles (FCV), fuel cell discharge system at the vehicle exhaust system's point of discharge, the hydrogen concentration level shall not exceed 4 % average by volume during any moving three-second time interval during normal operation including start-up and shut down[1]. FC stack need to washout by the concentrated hydrogen as the purge gas and how to exhaust gas without exceeding 4 % is the most concerns [9]. Also how to measure hydrogen pulse of millisecond in exhaust is also the rising up issue. Further more, any single failure downstream of the main H₂ shut off valve shall not result in a H₂ concentration in air of 4 % or more by volume within the passenger compartment. If a single failure down stream of the main hydrogen shut off valve results in a H₂ concentration in air of 4 % by volume within an enclosed or semi enclosed space in vehicle, the main H₂ shutoff valve shall be closed and warning to the driver shall be provided. [8] In this paper, model of FCV hydrogen discharge system was composed of plastic tube with pressure gage, Mass Flow controllers and Solenoid valves. Variety of simple experiments, injection, mixing, change flow rate and change tube inside diameter were carried out to control the H₂ concentration also Nitrogen (N₂) instead of Air. In mixing experiment, H₂ gas was introduced in the N₂ flow to form the various H₂ concentrations. H₂ at the point of discharge was monitored by the real time H₂ monitoring system Sx. The fast solenoid valve was opened within 3 milliseconds to add H₂ gas in N₂ flow, H₂ gas ran through the tube by mixing with N₂, and the wave front at the point of discharge was observed. In the milliseconds following the mixing process the

separated phases were shown by the real time H₂ sensor and the wave front concentration of H₂ during stop and release type of motions was topics. In milliseconds diffusion mechanism does not work and Reyleigh-Taylor instability might work [10].

In order to detect low concentration of H₂ in real time at the same time other gases, various kinds of hydrogen detectors existing but each sensor has difficulties to measure 0-100 % concentration of hydrogen. Semiconductor gas sensor, for example, cannot measure 100 % hydrogen. Catalytic gas sensor with filter needs time for hydrogen to penetrate filter. In order to detect hydrogen in real time, mass spectrometer system with differential pumping stage was selected to develop real time monitoring system and applied to H₂/N₂ mixing experiments [5,6]. In hydrogen release experiment on the mountain, high pressure H₂ gas was emitted from the pipe in the air to form the various H₂ concentrations of cloud. H₂ diffusion process was monitored by the real time H₂ monitoring system [5, 7].

2. Experimental

2-1 Sx H₂ Sensor

Photo images of Sx H₂ Sensor and outdoor experiment on the mountain are shown in Fig. 1&2.



Fig.1 Sx Image



Fig.2 Sx outdoor experiment on the mountain

Schematic diagram of Sx is shown in Fig.3. Weight of Sx is 25kg and portable for the outdoor mountain experiment [5]. When Sx measure H_2 , alarm red light is on. Liquid crystal touch panel is used to control Sx to start by changing valves. Sx has self-calibration system having certain concentration of single to mixed calibration gases. And having these calibration lines for each gas, Sx can monitor and show the concentration of each gas immediately. Real time monitoring is carried out from 2ms to 30ms. For the real time monitoring system inside volume of Sx is minimized. Sampling inlet of this system is 150-250 μm SUS capillary tube. Gas sample is introduced from capillary through dehumidifier and skimmer to ionization chamber. This system having differential pumping system to analyze gas, ionize hydrogen by electron bombardment method (EB). To minimize the humidity influence, Sx having dehumidifier is heated. Mass Spectrometer system works up to $m/Z=300$. [7]

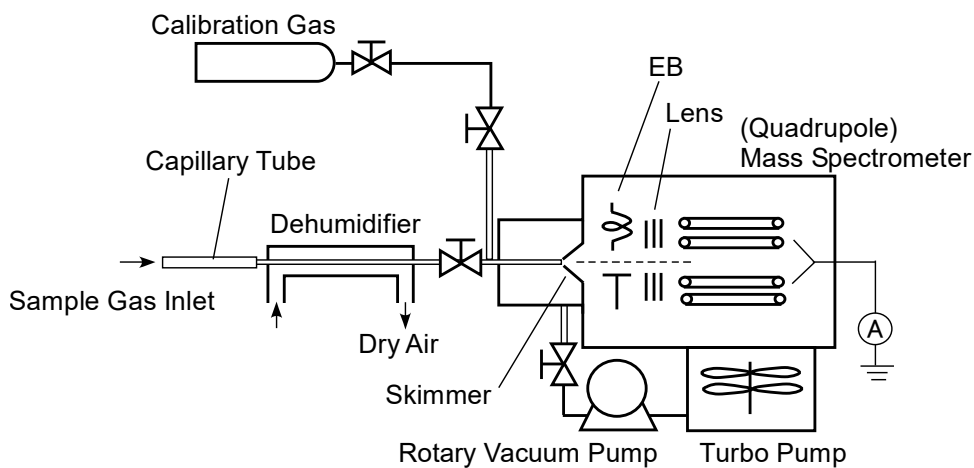

Fig.3 Sx Schematic Diagram

2-2 Mixing Hydrogen with Nitrogen

2-2-1 Mixing Hydrogen with Nitrogen in Cylinder

Schematic diagram of cylinder experiment is shown in Fig.4. Before cylinder (Swagelok SUS304 3.8L) is filled by H_2 , cylinder is reduced the pressure by vacuum pump and N_2 is introduced up to the atmospheric pressure. The position of cylinder is in two ways, vertical and horizontal. Both cases, the same cylinder with valves are used. So hydrogen is introduced by open up valve into cylinder from the atmospheric pressure to 0.1Mpa. The pressure inside is checked by the pressure gauge. The composition of gases inside the cylinder is monitored by Sx using 4 channels(Time, H_2 , N_2 and O_2) are measured by 30ms intervals.

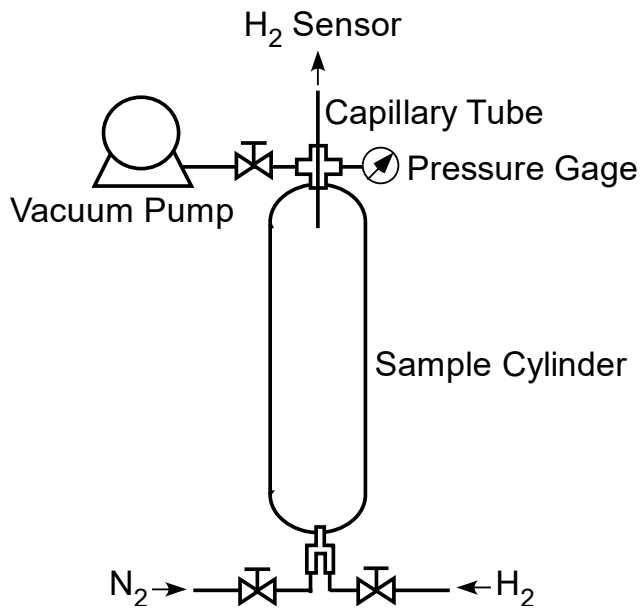

Fig. 4 Schematic Diagram H₂ in Cylinder Experiment (Vertical)

2-2-2 Vertical mixing (right-angle mixing head)

Nitrogen flow is controlled by Mass flow controller (Kofloc Kyoto Model 38100SII-V-1, N₂, In 0.15/out 0 Mpa, 100SLM, 20°C, 1 atm) with solenoid valve (CKD AB41-02-7 0.25Mpa) to maintain constant flow rate of 5L/min. Hydrogen is added vertically or coaxially to nitrogen flow at the constant flow rate and pressure through Mass flow controller (Kofloc Kyoto Model 3810DS-V, H₂, In 0.20/out 0 Mpa, 100SLM, 20°C, 1 atm) and solenoid valve (CKD AB41-02-7 0.25Mpa) to maintain and check flow rate, and start mixing by quick solenoid valve (KOGANEI K2-100SA-09, 0.2-0.5Mpa) in Fig.5.

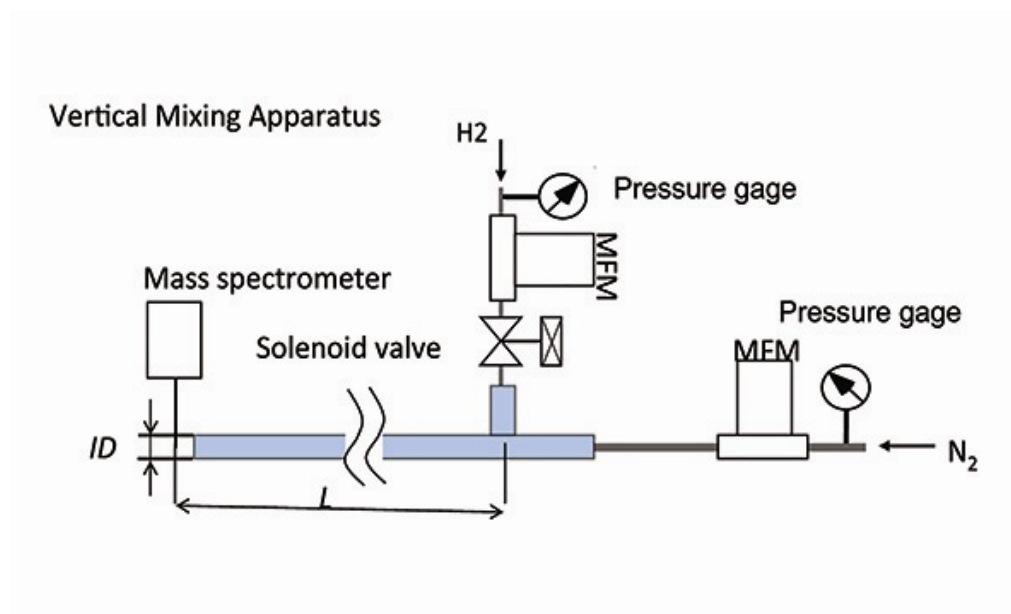

Figure 5. Vertical mixing (right-angle mixing head).

3 Results and Discussions

3-1 Basic Performance and Response of Sx

In Fig.6, Sx sensor output vs H₂ Concentration was measured by Log-Log plot. Sx could measure hydrogen from 100ppm to 100% without changing range of concentration. Linear relationship was obtained between the Sx output and the introduced hydrogen concentration.

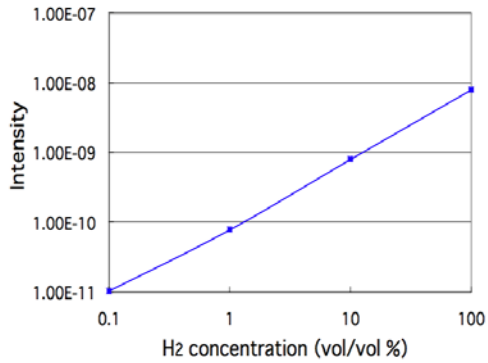

Fig.6 Sx Sensor Output vs H₂ Concentration Log/Log

When H₂ was introduced to Sx by the equipment Fig. 5, Sx reacts toward increasing hydrogen concentration immediately less than 0.3sec and reached the maximum concentration.

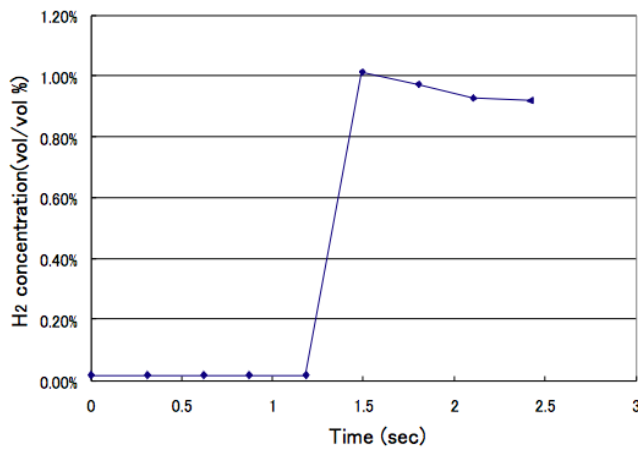

Fig.7 H₂ Response during Valve Open

Sx reacts toward decreasing hydrogen phase immediately less than 0.3sec and return to wait to next coming phase.

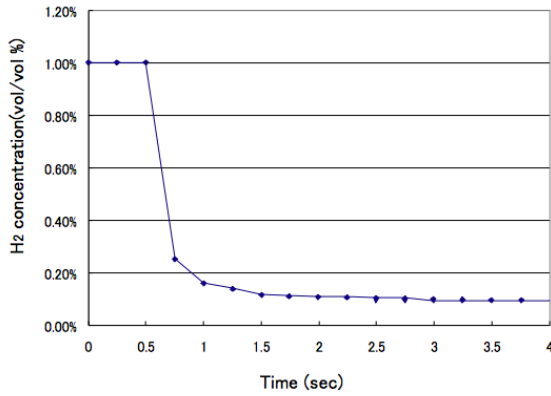

Fig.8 H₂ Response during Valve Close

3-2 Response of repeatedly introduced hydrogen

Under constant flow of N₂ controlled by massflow controller, hydrogen was repeatedly introduced. The result by Sx was shown in Fig.9. In this experiment 4 channels were used to monitor H₂,N₂,O₂, and time. Data was taken in 30ms interval. The response time observed was less than 0.3sec for both increasing and decreasing hydrogen concentration.

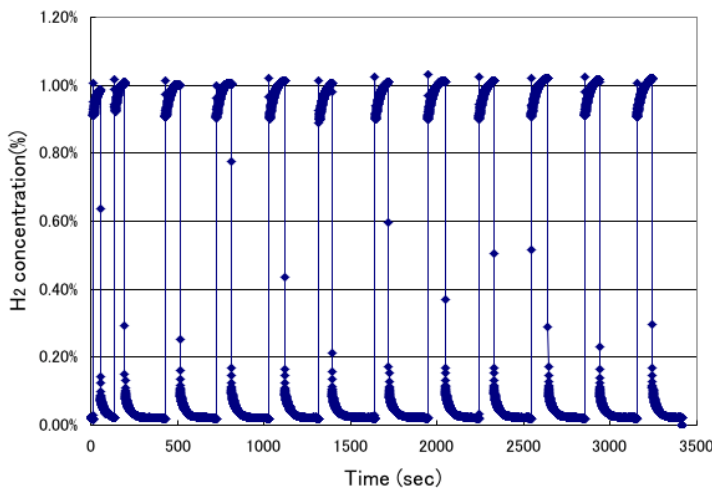

Fig.9 Sx Response by Periodical Introduction of Low concentration H₂

3-3 Real Time Monitoring of Purged H₂ into Nitrogen flow

Under constant flow of N₂ 5L/min controlled by massflow controller, hydrogen were introduced by quick valve at the flow rate of about 1.5L/min by using vertical mixing with right-angle mixing head shown in Fig.5. The result of H₂ concentration by time was shown in Fig.10. In this experiment single channel was used to monitor H₂. Measurement interval was less than 10ms. In this experiment, first hydrogen wave came with the spike head where the highest concentration of hydrogen (C_{max}) reached as a cloud by open up quick valve and then reached the equilibrium (C_{eq}). Hydrogen was introduced into N₂ flow without diffusion and kept the concentration as H₂ cloud. The concentration of spike was more than the expected concentration of about 30% but 45%, and 1.5 times higher level. From the point of safety sake we decided to analyse this spike.

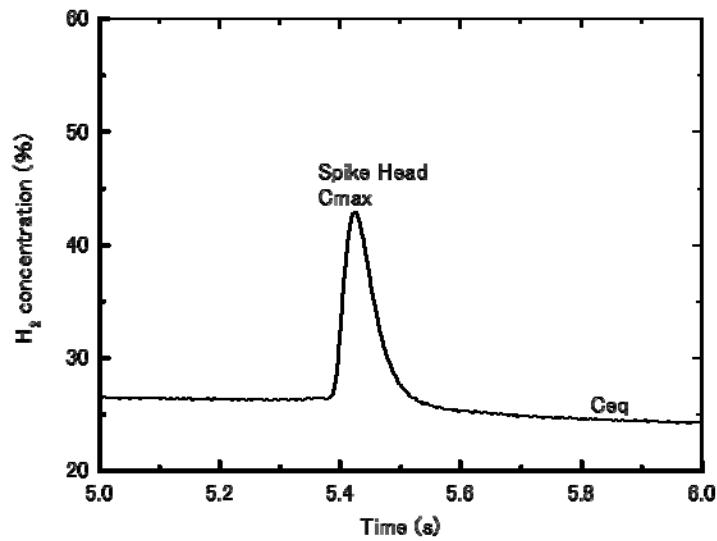

Fig.10 H₂ Response by Quick Valve

By changing the duration time of quick valve open from 1 to 100ms, the spikes change the shapes and the result are shown in Fig.11. At duration time of 1ms the quick valve motion did not follow and enough volume of hydrogen did not move into N₂ flow. The height of Spike head reached the maximum during duration time of 5-10ms and when duration time reach 100ms, the height of spike head became lower and the width of spike became wider shown in Fig. 12(b). This means that induration time of 100ms hydrogen volume in spike head increased compared to lower duration time data shown in Fig. 12(a) . The analysis of this spike head is also discussed in another ICHS paper.

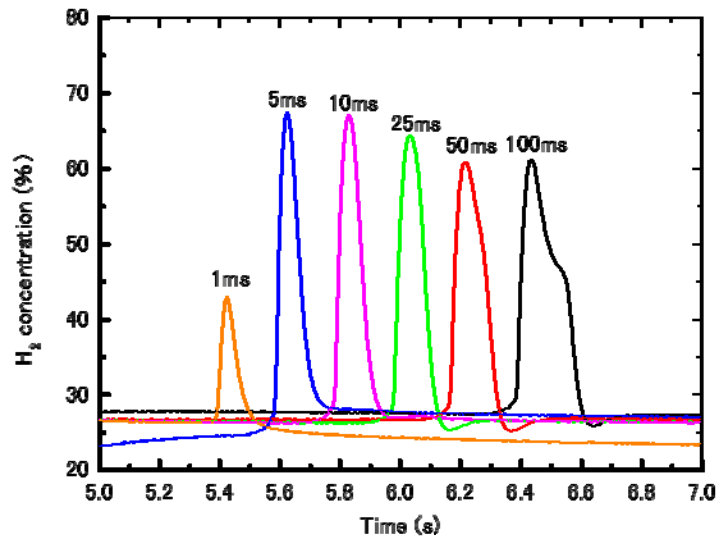
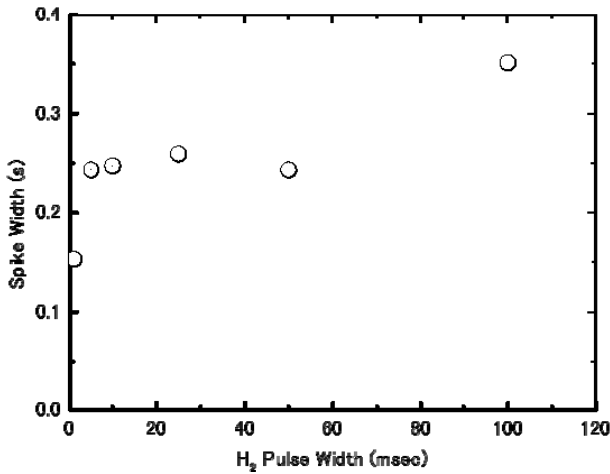
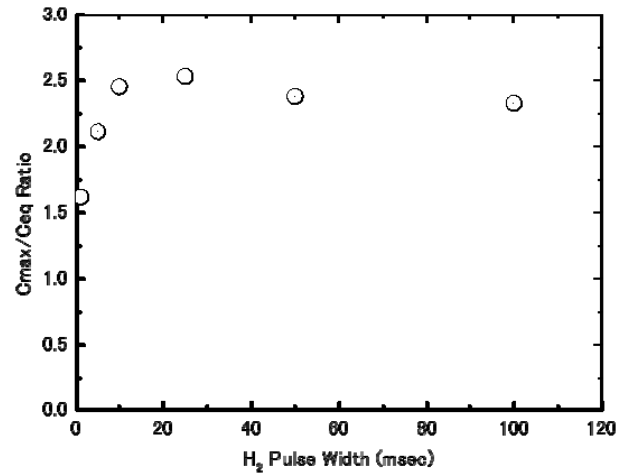

Fig.11 Spike heads by response time 1-100ms



(a) Spike Width



(b) C_{max}/C_{eq} Ratio

Fig.12 Spike head analysis by Periodic square wave pulse H₂ injection

Spike head analysis are undertaken and structure of spikes are measured and plotted in Fig12.

3-4 Visualization of H₂ cloud

Visualization of H₂ cloud in transparent plastic tube was carried out. Experimental setting was shown in Fig.13. Transparent acrylic resin tube was placed vertically on the desk and about 10cm³ of hydrogen was introduced by plastic syringe in the tube. The tube inside diameter was 26φ and inlet port was also shown in this Figure. The height of inlet port was 10mm. Diameter of inlet for syringe was 3.9mm. After injection of hydrogen by syringe, H₂ flow rotationally following the way to the outlet located at the center and pushed out in to the tube. The diameter of outlet is 10mm. The direction of this flow was the centreline of this plastic tube. In this tube, smoke particle from mosquito coil was filled before the experiment. The movement of the smoke particles were monitored by CCD camera after H₂ injection. After the introduction of 10cm³ hydrogen, H₂ moved as a mass rather than diffuse homogeneously, went upward along the tube. The photo was shown in Fig.9

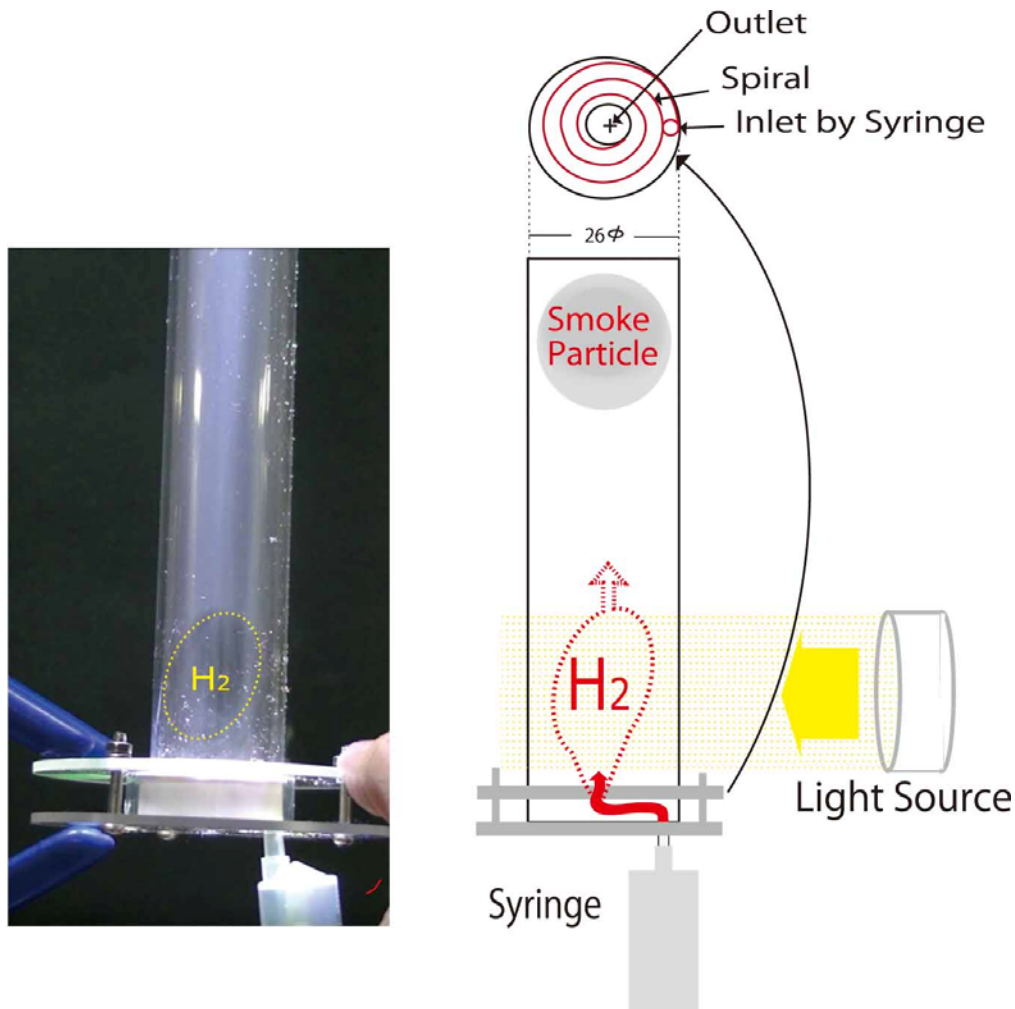

Fig.13 Visualization of H₂ Bubble by Smoke Particles.

H₂ bubble from syringe through tangential inlet port

Plastic pipe inside diameter of $\Phi 26$.

3-5 H₂ introduction to Cylinder

Similar experiments were set by using SUS cylinder shown in Fig. 4. Two ways of settings, horizontal setting and vertical setting were examined. In this experiment H₂ was introduced into the cylinder from horizontal direction and vertical direction from the bottom of the cylinder. When the cylinder was horizontal setting, introduced hydrogen diffuse homogeneously and the concentration of H₂ was increased by time smoothly. But in vertical setting, the observed concentration of H₂ by Sx was shown in Fig. 15 and 16. In Fig. 15, the concentration of H₂ and N₂ in Cylinder was shown and H₂ increase also N₂ decreased in the zigzag manner with some spikes. Fig.16 showed the precise behavior of H₂. H₂ with the top concentration of the clouds were passing upward one by one. So the cloud rather stayed still without diffusion because of the existence of the buoyancy.

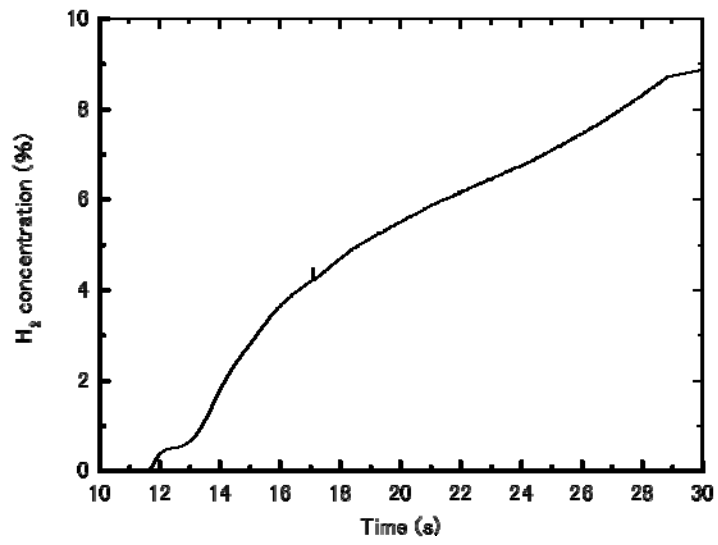

Fig.14 Concentration of H₂ in Tank by Time 10 second Horizontally

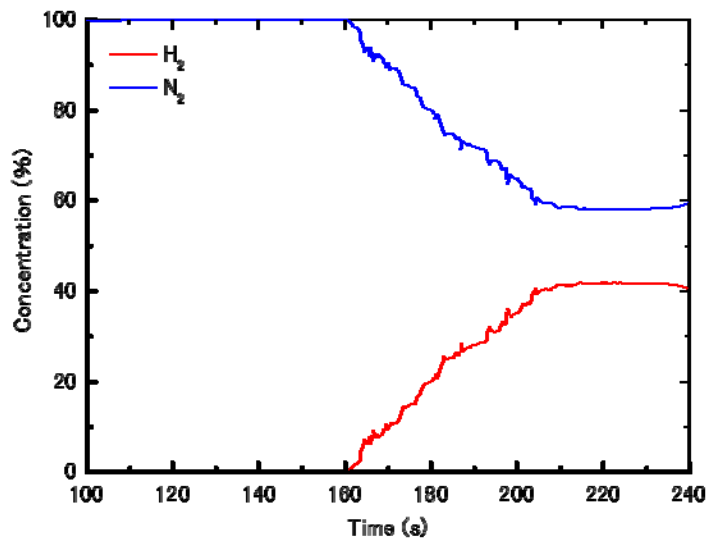

Fig.15 Concentration of H₂ in Cylinder by Time 10 second Vertically

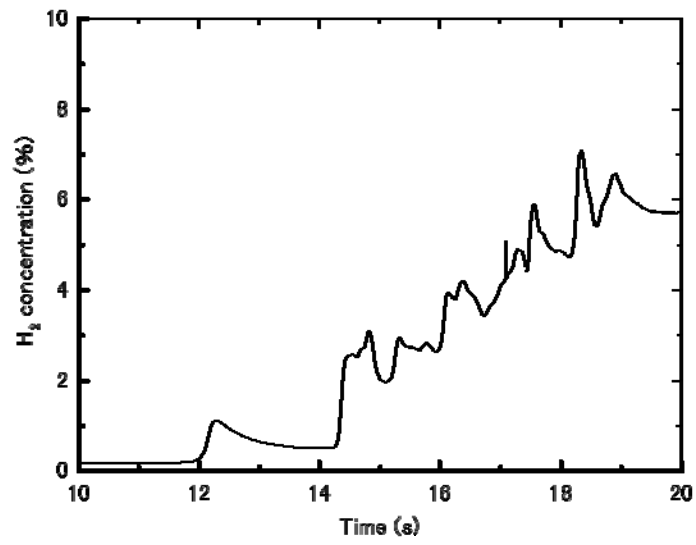

Fig.16 Concentration of H₂ in Cylinder by Time 10 second Vertically

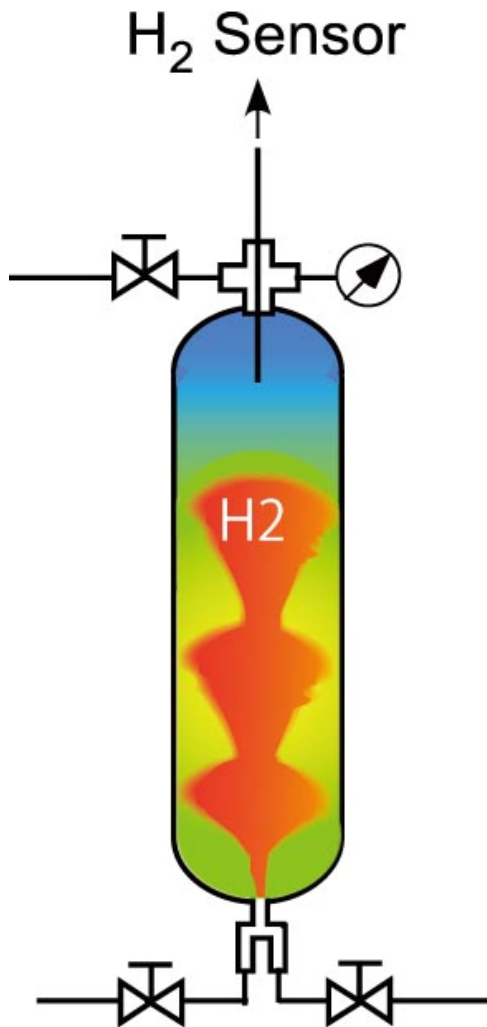

Fig.17 Schematic diagram of H₂ cloud in Cylinder

3-6 Hydrogen Spike Head by FCV Exhaust Gas

Hydrogen gas concentration of FCV Exhaust Gas was monitored by Sx by fitting sampling capillary at the discharging point of the center of exhaust pipe exit with small protector plate toward water droplet to come in Fig.18. The hydrogen measurement was conducted by 2-10ms interval when FCV was parked and while idling position. So every 2ms the hydrogen concentration was taken by time. Sx data were shown in Fig. 19,20 and 21. In Fig.19, about every 60 second, H₂ spike came out from exhaust gas as spike. The width of spike was about 1second of time. By spike analysis shown in Fig. 20, one spike peak was composed of 2 or more spikes within 1 second and shape of spike reflecting structure of Fuel Cell stack. These data was taken in very short millisecond measurement and the existence of water. Insertion of hydrogen mass into nitrogen without diffusion is similar to



Fig. 18 FCV Exhaust gas at the discharge point

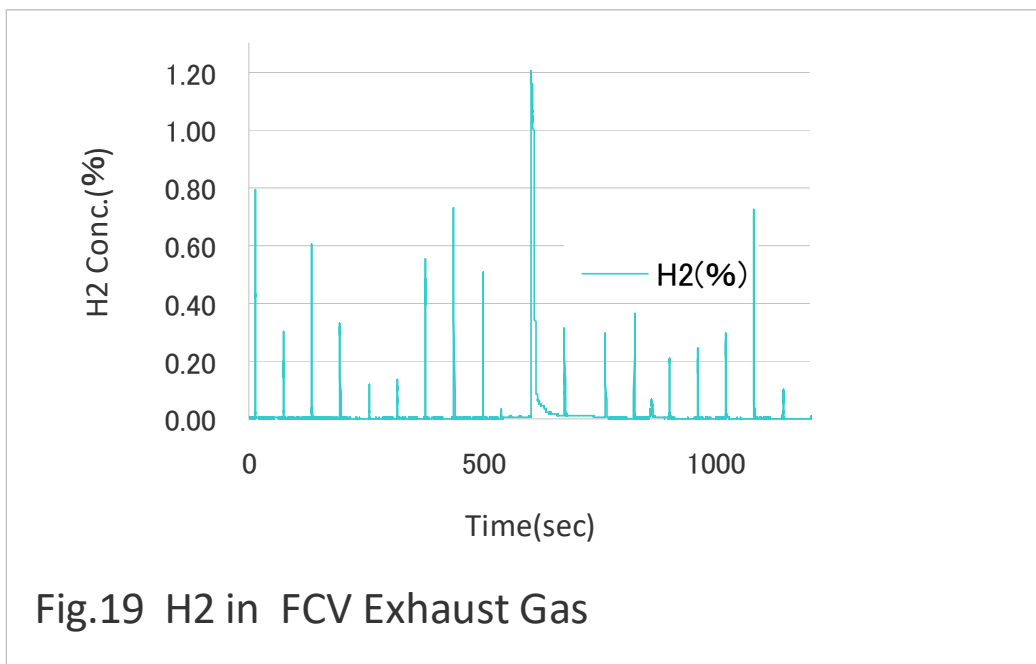

Fig.19 H2 in FCV Exhaust Gas

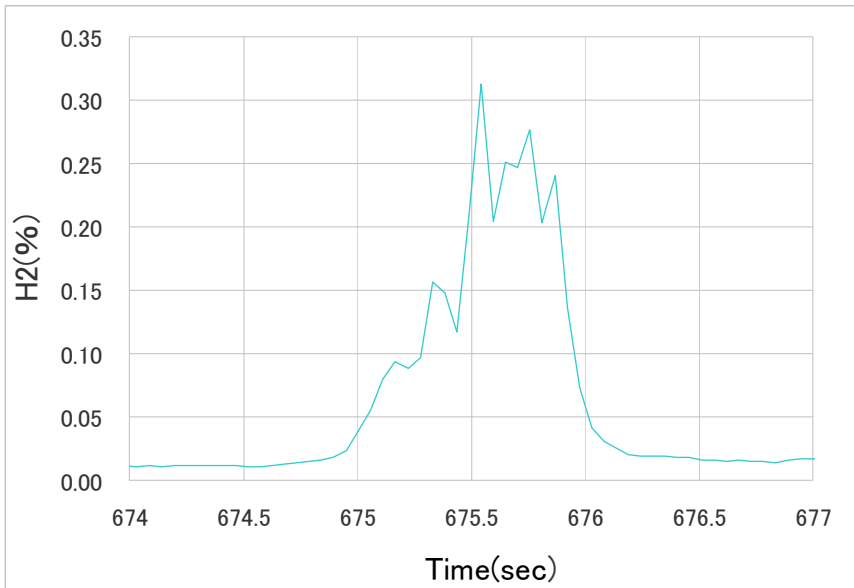

Fig.20 H2 Pulse in Exhaust FCV

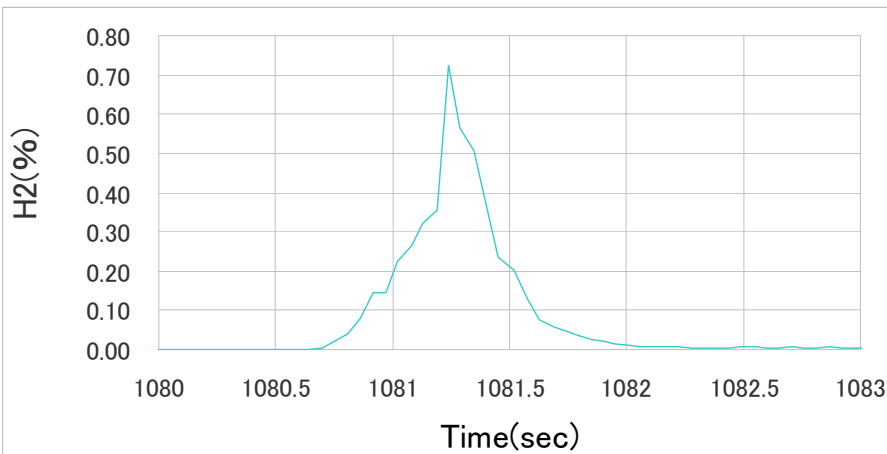

Fig.21 H2 Pulse in Exhaust Gas

4 Conclusion

Real time monitoring of Hydrogen by Sx showed hydrogen clouds before diffusion. Our actual data showed the difference from the perception before conducting the experiment and the simulation. The high concentration phase of hydrogen clouds survives and moves upward by buoyancy or flow forming the spike head rather than homogeneously diffusing. Also when mixing proceeds, the head of hydrogen cloud moves straight to form the spike head as observed in millisecond monitored by Sx. In the cylinder experiment and also the transparent plastic tube experiment showed H₂ cloud movement upward rather than diffusing in all directions. Hydrogen in spike stay with high concentration forming cloud and the similar

spike was appeared in FCV exhaust gas in every purging action. In basic theory of Rayleigh-Taylor instability, if the two gas phases instead of the two fluids with different densities was considered, the spike head might be came out as a cloud which we observed by Sx.

The instability of the plane interface between the two fluids, when it occurs, is called the Rayleigh-Taylor instability”

5 REFERENCES

1. ECE/TRANS/180/Add.13,HFCV-GTR,
http://www.unece.org/trans/main/wp29/wp29wgs/wp29gen/wp29glob_registry.html
2. Schefer RW, Houf WG, Williams TC, Investigation of small scale unintended release of hydrogen:momentum dominated regime,Int.,*J Hydrogen Energy*,33,6373-84(2008)
3. Schefer RW, Houf WG, Williams TC, Investigation of small scale unintended release of hydrogen:buoyancy effects, Int.,*J Hydrogen Energy*,33,4702-12(2008)
4. Schefer RW, Evans GH, Zhang J, Ruggles AJ, Greif R, Instability limit for combustion of unintended hydrogen release: Experimental and theoretical results, Int.,*J Hydrogen Energy*,36,2426-35(2011)
5. Mogi, T. ,Nishida, H. and Horiguchi, S. , *Safety Eng.*,44,No6, 44, (2005) (in Japanese)
6. Nohmi,T. and Fenn,J.B, *Electrospray, Mass Spectrometry, J.Am.Chem.Soc.*,Vol.114,No.9,p3241-3246(1992) .
7. Nohmi,T.,Maekawa,M.,Mogi, T., *Hydrogen Ion Sensor,HESS*,Vol.33,No2,1(2008)
8. Furusawa, K., Nagoshi, K., Tanimoto, S., *Honda R&D Technical Review* 23, No.24, 279(2012)
9. Matsumoto, M., Shimizu, K., *Research of Simulation Method of Hydrogen Diffusion for Fuel Cell ElectricVehicle Development, Honda R&D Technical Review* 23, No.1, April, p.56-61(2011).
10. Nohmi, T., *Ion formation and Electrospray, J. Mass Spectrom. Soc. Japan*, Vol.44, No.2, p.105-122(1996). (in Japanese)