

HYDROGEN - METHANE MIXTURES : DISPERSION AND STRATIFICATION STUDIES

A. Marangon , M.N. Carcassi

Department of Mechanical, Nuclear and Production Engineering, University of Pisa, Via Largo Lucio Lazzarino, 2, Pisa, 56122, Italy. a.marangon@ing.unipi.it

ABSTRACT

The study of hydrogen as an alternative fuel, clean and “environment friendly”, has been in the last years and continues to be object of many studies, international projects and standard development. Hydrogen is a fundamental energy carrier, to be developed together with other renewable resources, for the transition to a sustainable energy system.

But experience has shown how often the introduction and establishment of a new technology does not necessarily pass through radical changes, but can be stimulated by slight modifications to the “present situation”.

So the worldwide experience with natural gas, as industrial, automotive and domestic fuel, has been the incentive to the present interest towards hydrogen-methane mixtures. The possible use of existing pipeline networks for mixtures of natural gas and hydrogen offers a unique and cost-effective opportunity to initiate the progressive introduction of hydrogen as part of the development of a full hydrogen system.

The aim of the work presented in this paper is the investigation of the dispersion and stratification properties of hydrogen and methane mixtures. Experimental activities have been carried out in a large scale closed apparatus, characterized by a volume of 25 m³, both with and without natural ventilation. Mixtures of 10%vol. hydrogen – 90%vol. methane and 30%vol. hydrogen – 70%vol. methane have been studied with the help of oxygen sensors and gas chromatography.

KEYWORDS

Hydrogen, methane, mixtures, dispersion, experimental activities.

1.0 INTRODUCTION

Hydrogen as an alternative fuel, clean and “environment friendly”, has been studied and continues to be investigated for its employment both in automotive and in domestic application. However for a complete transition to an hydrogen economy, major investment are needed for the development and building of infrastructure mainly for production and distribution. Moreover experience has shown how often the introduction and establishment of a new technology does not necessarily pass through radical changes, but can be stimulated by slight modifications to the “present situation”. So the worldwide experience with natural gas, as industrial, automotive and domestic fuel, has been the incentive to the present interest towards hydrogen-methane mixtures. The possible use of existing pipeline networks for mixtures of natural gas and hydrogen offers a unique and cost-effective opportunity to initiate the progressive introduction of hydrogen as part of the development of a full hydrogen system.

Hydrogen-methane mixtures have different properties compared with pure methane, as the addition of hydrogen could introduce minor or major safety problems depending on the volumetric percentage of hydrogen added, i.e. fugitive emissions are larger with hydrogen, as well as the reactivity of the gas, etc. Moreover the mixture is lighter compared to pure methane and the volumetric flow rate, for the same pressure and leak size, is greater than the equivalent one involving methane [I].

To assess the different behaviour of the hydrogen / methane mixtures, experimental activities are needed, so a series of tests have been conducted to investigate the dispersion and the long term stratification in a closed apparatus of about 25 m³ with and without natural ventilation. This apparatus, called CVE, could be representative of domestic room, garages or compressor building.

Mixtures composed of 10%vol. hydrogen - 90%vol. methane and 30%vol. hydrogen - 70%vol. methane have been tested. Mixtures concentration measurements in the internal volume have been carried out through several oxygen sensors and gas chromatography technique.

2.0 DESCRIPTION OF THE EXPERIMENTAL CAMPAIGN

2.1 Experimental apparatus

The experiments have been carried out at the DIMNP test site in Tirrenia, Pisa, Italy [II].

The CVE apparatus is a cubic structure characterized by an internal volume of about 25 m³ and hence it could be representative of domestic room, garages or compressor building. The roof and one side face are entirely covered with panels of glass which allow to video record the explosion and the flame expansion. All the other faces are covered with steel panels having different functions. The bottom and one side faces are entirely made of steel strengthened panels which are not removable, while the other two lateral faces, on opposite side, are the test vent (plastic surface) and the safety vent respectively (steel panels).



Figure 1 - CVE apparatus

In the opposite walls (test and safety) ventilation openings have been designed. Openings could be varied in number and area (see figure 2 and figure 5): the maximum number was two openings per side with an area of 0,035 m² each. The ventilation openings are located at 160 mm from the ceiling

and at 160 mm from the floor and symmetrically located at 0,065 m from the central axis of the experimental facility. Each one was characterized by the following dimensions: 0,063 m x 0,560 m.



Figure 2 - Natural ventilation openings

The gas supply line and the instrumentation used are represented in figure 3; the gas was stored in high pressure bottles. Two different mixtures have been tested: 10%vol. Hydrogen / 90%vol. Methane and 30%vol. Hydrogen / 70 %vol. methane. These mixtures will be called as 10-90 and 30-70 respectively. This specific volumetric fractions were selected since they are both within the ISO definition of methane / hydrogen blends according to its Position Paper [III].

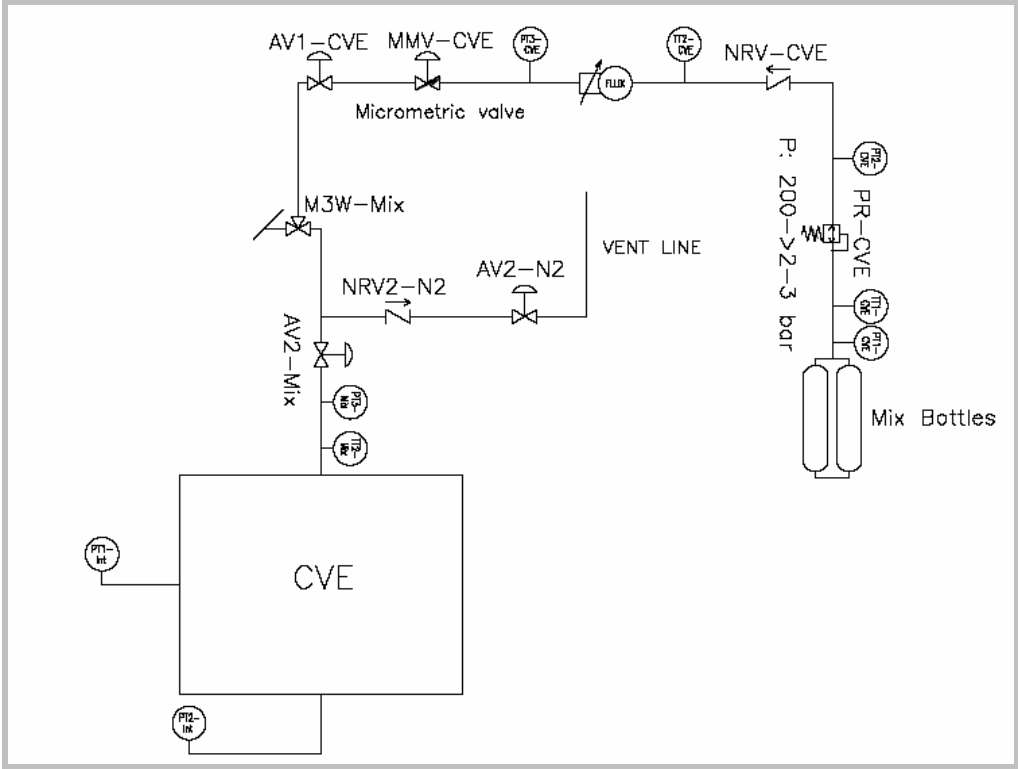

Figure 3 – Gas supply line and instrumentation

The following instrumentation was installed:

- ◆ A piezoelectric pressure gauge placed on the gas bottles (PT1-CVE);
- ◆ A thermo-resistance placed on the gas bottles (TT1-CVE),
- ◆ A pressure reducer (PR-CVE);
- ◆ A piezoelectric pressure gauge placed downstream the pressure reducer (PT2-CVE);
- ◆ A thermo-resistance placed downstream the pressure reducer (TT2-CVE);
- ◆ A piezoelectric pressure gauge placed downstream the flow meter (PT3-CVE);
- ◆ A micrometric valve to adjust the mixture release flow rate;
- ◆ A piezoelectric pressure gauge placed upstream the mixture release point (PT3-MIX);
- ◆ A thermo-resistance placed upstream the mixture release point (TT2-MIX);

2.2 Description of the concentration measurement technique

To measure the mixture concentration within the internal volume of the CVE, 7 oxygen sensor and 3 sampling line to gas chromatograph were used.

The oxygen sensors were electrochemical cells SM3 II GD, “SMART 3 gas detectors” series commercialised by the Sensitron s.r.l. [IV]. They are able to measure oxygen concentration in the range of 0-30%vol have an accuracy of 0.1%vol. a measurement stabilization time of 2 minutes and a response time of less of 15 seconds.

At the beginning of each test, prior to activation of the gas release, the output signals of the oxygen cells were recorded for 60 seconds and then the average lecture was taken as representative of the oxygen concentration in the atmosphere corresponding to 0% gas. During the test, with the release of mixture within the experimental apparatus, the detected oxygen concentration decreased, being linearly related to the concentration of gas (See Eq.1).

$$X_{mix} = 1 - \frac{x_{O_2}}{\langle x_{O_2} \rangle} \quad \text{Eq. 1}$$

Where:

- ◆ $\langle X_{O_2} \rangle$: average lecture of the oxygen sensor on 60 seconds (representative of the oxygen concentration in the atmosphere corresponding to 0% gas);
- ◆ X_{O_2} : oxygen lecture during the experiment with mixture within the CVE apparatus.

The oxygen sensor position within the CVE is represented in Figure 4 and the relative heights were the following:

- ◆ Sensors n. 1, 4 and 5: located at 2,82 m from the floor;
- ◆ Sensors n. 3 and 6: located at 1,45 m from the floor;
- ◆ Sensor n. 2 and 7: located at 0,03 m from the floor.

The dimensions of the CVE are: 2,752 m X 3,233 m X 2,814 m height.

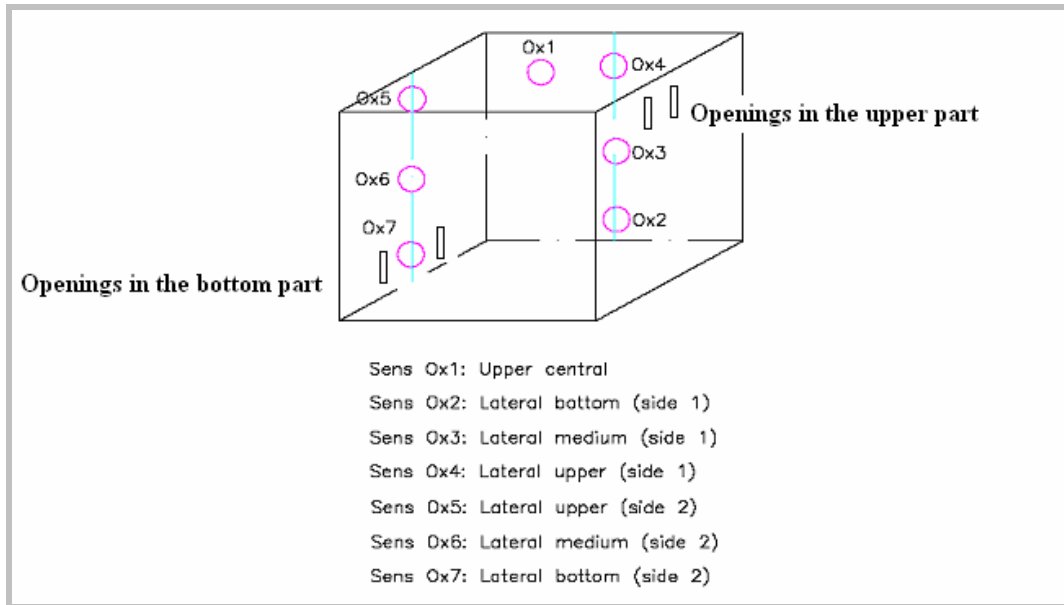

Figure 4 - Openings and oxygen sensors position

The gas chromatograph was a solid-gas column with a TCD detector (Thermo-Conductivity Detector). Three sampling line were upgraded in the apparatus: one in the central upper part (same line of the Sens Ox1), one in the upper-lateral part (same line of the Sens Ox4) and finally the last one in the medium lateral part of the CVE (same line of the Sens Ox3). The sampling to be delivered to the gas chromatograph were manually done through a syringe.

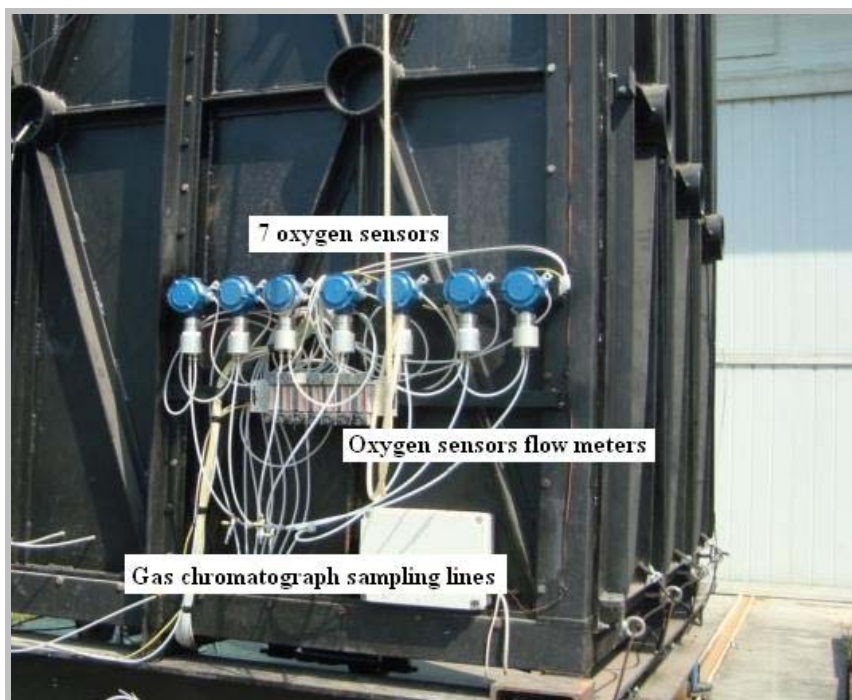

Figure 5 - Oxygen sensor and gas chromatograph sampling lines

3.0 TEST MATRIX

In table 1 the parameters of seven tests are showed. The mixture release hole diameter was equal to ½ ” and the release pressure was about 30 mbar for all the tests. The release point was located in the centre of the floor and upward directed.

This tests configurations are representative for example of domestic applications or fugitive emission from joints in closed environments with or without natural ventilation.

In the next chapter only the results of some test are showed.

Table 1 – Experimental matrix for some tests

DATE AND TEST NUMBER	MIXTURE	NATURAL VENTILATION	RELEASE TIME [sec]	RELEASE FLOW RATE [g/sec]	ΔP MIXTURE BOTTLES [bar]	ΔT MIXTURE BOTTLES [°C]
29 June 2010 TEST N.1	30%vol. H ₂ 70%vol.CH ₄	NO	530	2,016	28	1,0
02 July 2010 TEST N.2	30%vol. H ₂ 70%vol.CH ₄	YES Four identical openings on opposite side (Two in the upper part and two in the bottom part). Total area = 0,14 m ²	2890	1,23	65,5	3,5
13 July 2010 TEST N.3	10%vol. H ₂ 90%vol.CH ₄	NO	1580	1,16	24,5	2,7
21 July 2010 TEST N.4	10%vol. H ₂ 90%vol.CH ₄	YES Four identical openings on opposite side (Two in the upper part and two in the bottom part). Total area = 0,14 m ²	2969	1,31	58,5	0,5
04 January 2011 TEST N.5	10%vol. H ₂ 90%vol.CH ₄	YES Only one opening in the bottom part. Total area = 0,035 m ²	2023	1,5	33	1,0
05 January 2011 TEST N.6	10%vol. H ₂ 90%vol.CH ₄	YES Only one opening in the upper part. Total area = 0,035 m ²	2560	1,32	45,6	4,3
12 January 2011 TEST N.7	30%vol. H ₂ 70%vol.CH ₄	YES Only one opening in the upper part. Total area = 0,035 m ²	2750	1,31	57,6	2,7

4.0 RESULTS

In all the experiments a non homogeneous mixture concentration within the CVE was observed, both with and without natural ventilation and independently of natural ventilation openings position.

Moreover for long residence time and no ventilation a tendency to homogenization was also observed as showed in the next figures.

For test carried out with a higher mixture release flow rate (2,016 g/sec - test n.1), the gas concentration measured by sensor n.1 (located in the centre of the ceiling, see Figure 4, in direct view of the release point) was higher than the ones measured by sensors n. 4 and 5 (Figure 6), meaning that the gas flow somehow reached the sensor. Except for sensor n.1, all the other sensors located at the same height measured the same concentration values, meaning a well defined stratification within the CVE.

For tests carried out with a lower release flow rate (1,16 g/sec - test n.3), the gas concentration was well stratified and also sensor n.1 measured the same concentration value of sensors n.4 and 5, meaning that sensors located at the same height measured the same gas concentration's values (see Figure 7). Moreover there were no difference in gas concentration lectures between sensors located in the upper part and sensors located in the medium part of the CVE.

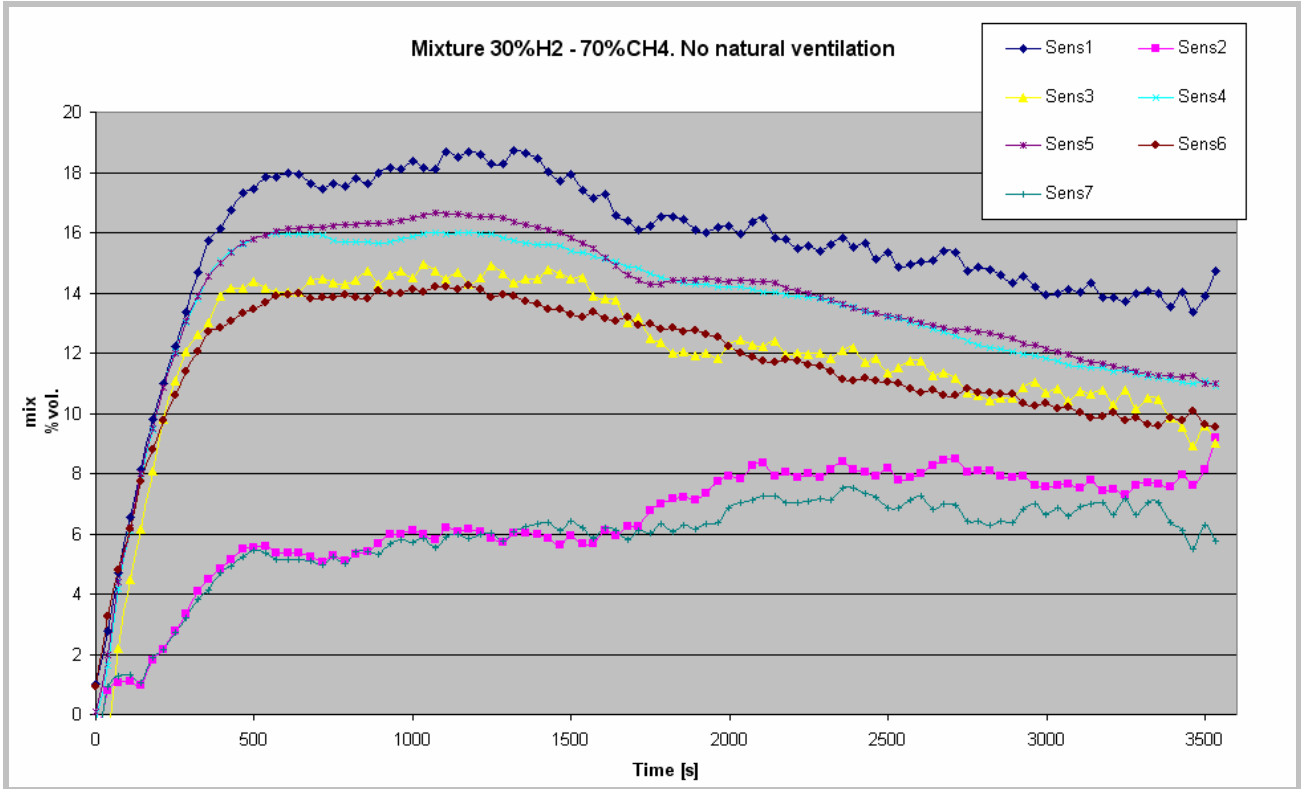

Figure 6 – 29/06/2010 test n.1 Mixture volumetric concentration

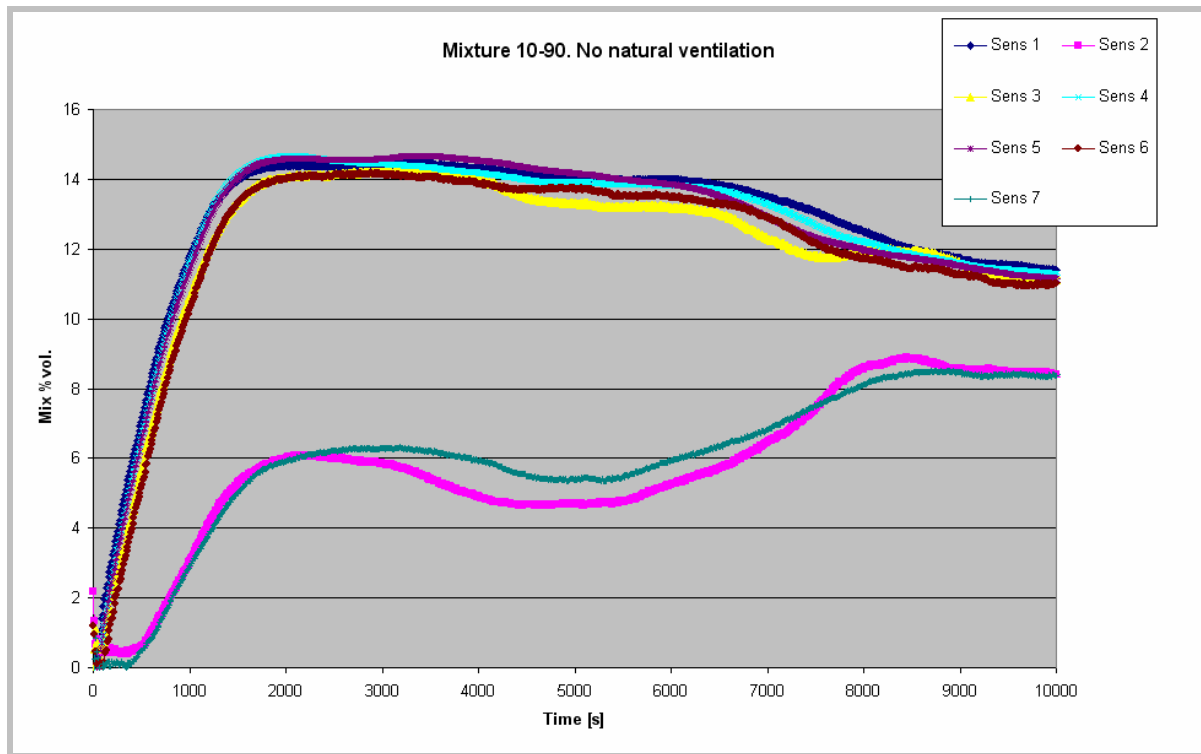

Figure 7 – 13/07/2010 test n.3 Mixture volumetric concentration

For test carried out with natural ventilation realized with openings on opposite sides of the CVE (in the upper part on one side and the bottom part in the other side), the gas concentration was not homogeneous in the horizontal planes of the CVE. In fact from Figure 8, it can be noted that the mixture concentration was higher for the sensor 5 and 6, which were located more distant from the CVE openings (see figure 5). This non uniform gas concentration was due to the air flow through the ventilation openings that created different zones, characterized by different concentration's values, even in the horizontal direction.

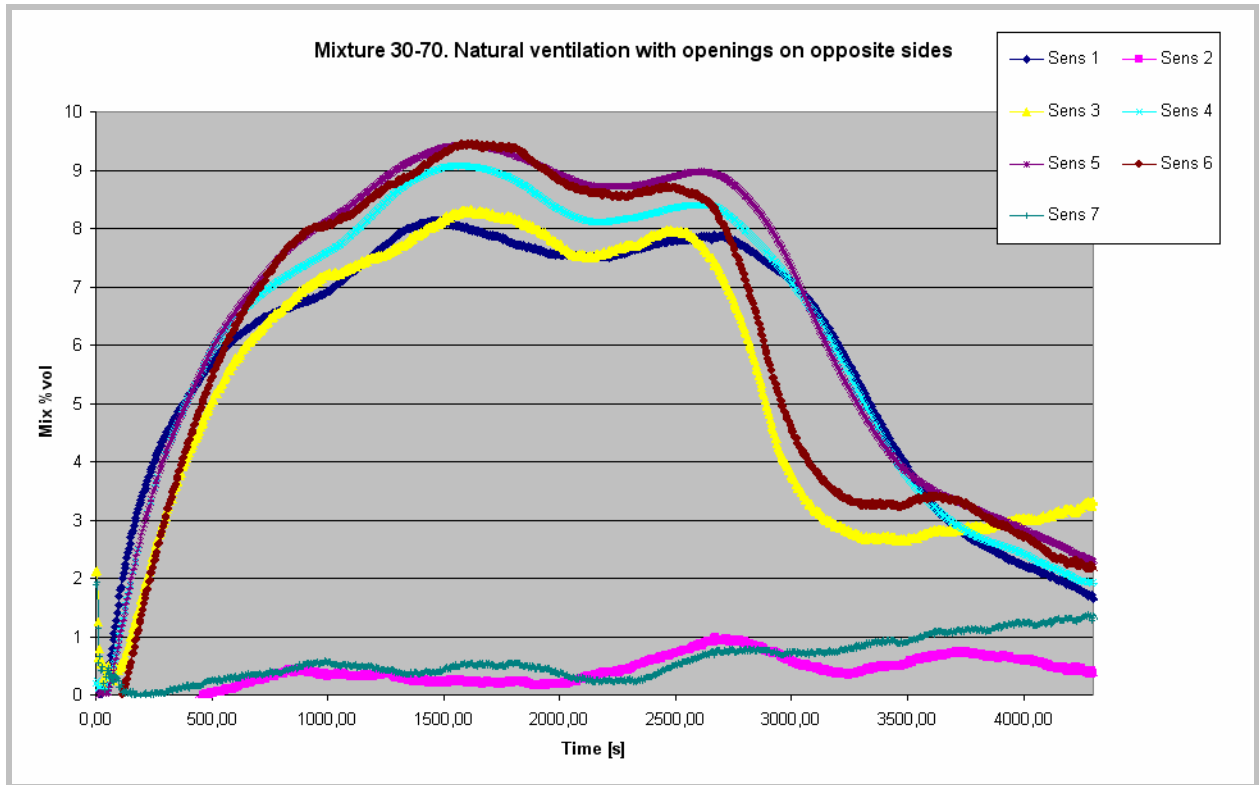

Figure 8 – 02/07/2010 test n.2 Mixture volumetric concentration

Below are presented the test results for experiments carried out with only one opening located or in the bottom or in the upper part of the CVE. In some tests the stratification within the CVE was well evident (see Figure 9), while in other tests, different values of concentration in the horizontal planes of the CVE were found (see Figure 10).

It is to be noted that when the stratification was so evident, the differences in temperature (ΔT) between the internal volume of the CVE and the outside ambient were smaller. In fact for test n. 6 (see Figure 9), the temperature of the internal volume of the CVE was between 9 and 9,5°C and the outside temperature air was of 3 - 4°C (for so long test the temperatures suffered of about 1°C of increment from the morning to noon). Instead for test n.11, where the measured gas concentration was not uniform in the horizontal planes of the CVE, the temperature of the internal volume of the CVE was between 17 and 18°C and the outside temperature air was equal to 2 - 3°C (also in this case for so long test the temperatures suffered of about 1°C of increment from the morning to noon).

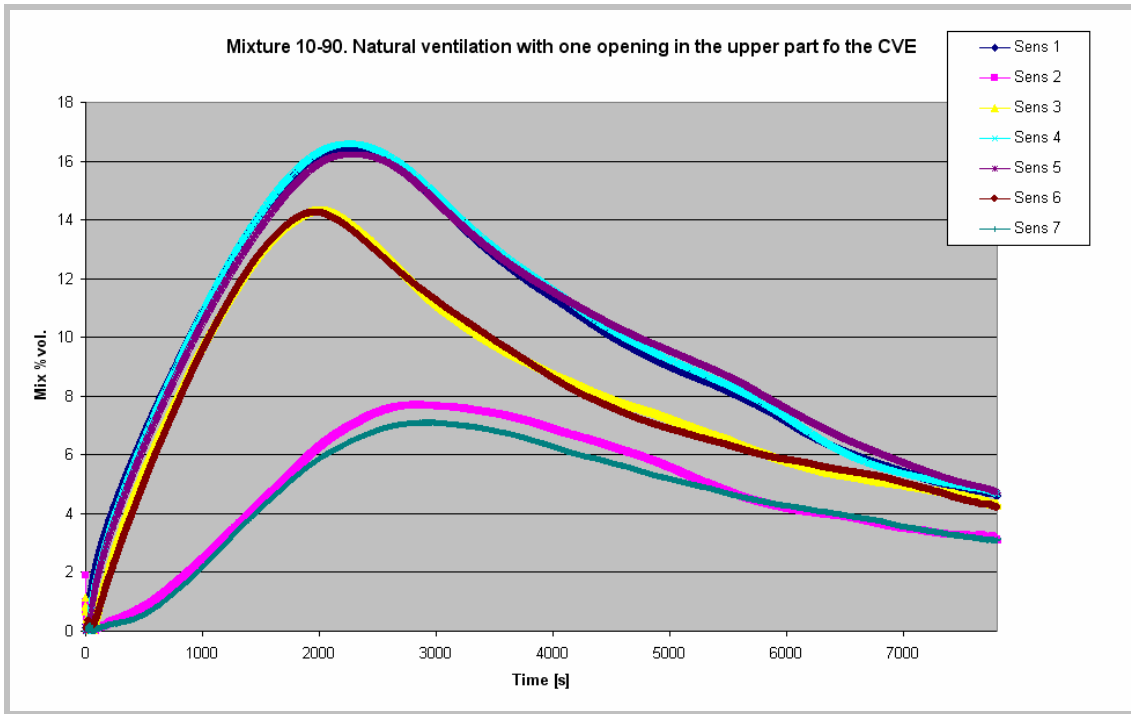

Figure 9 – 05/01/2011 test n.6 Mixture volumetric concentration

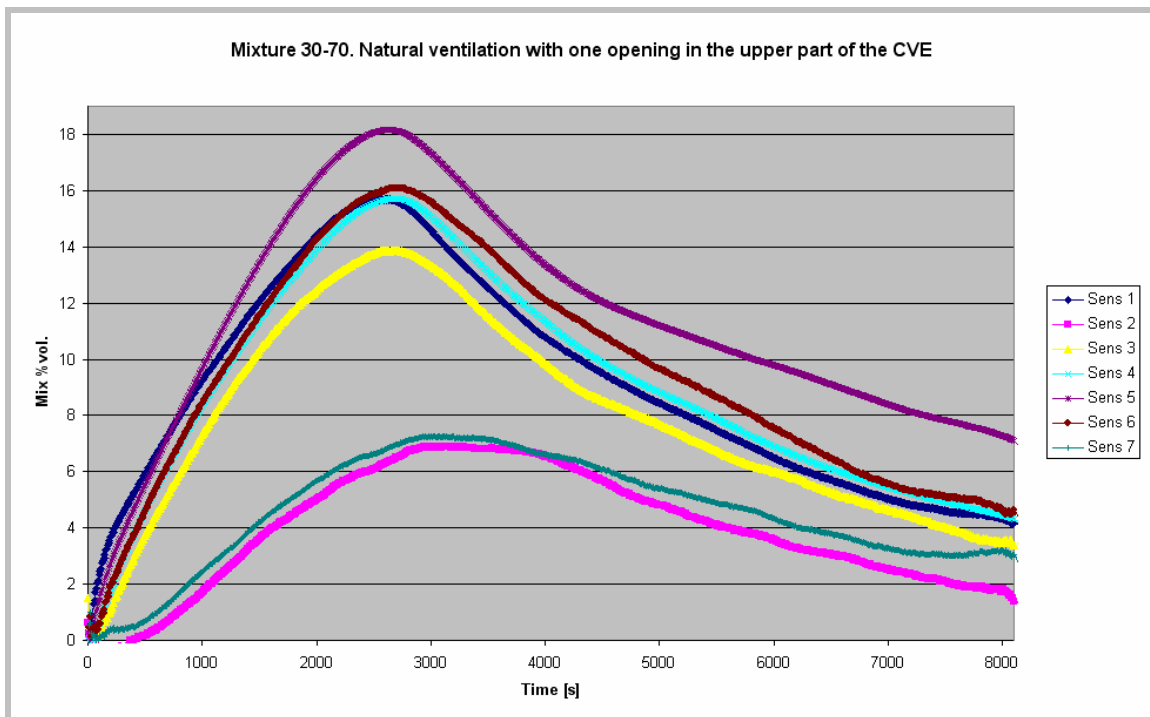

Figure 10 – 12/01/2011 test n.7 Mixture volumetric concentration

Moreover when the ΔT was higher, the concentration measured by the sensor located in the opposite side with respect to the opening location was higher (Sensor n.5 of Figure 10). Also the measurement of the sensor n. 6 was higher than the one of sensor n. 3, located at the same height, but on the side opposite to the opening, and was equal to the lectures of sensors n. 1 and 4 located in the upper part of the CVE (see Figure 10).

One test was carried out also with one opening located in the lower part of the CVE (see Figure 4 and Figure 11). As well known, the position of the opening is a fundamental parameter for a light gas dilution in a closed environment. In fact is evident that an opening located in the bottom part of a closed environment is not efficient (Figure 11) as it would be if located in the upper part (Figure 10 and Figure 10). With only one opening in the lower part of the CVE and a difference in temperature, between the internal volume and external ambient air, of about 3°C, the stratification was well evident with homogeneous concentration's values in the horizontal planes of the experimental facility.

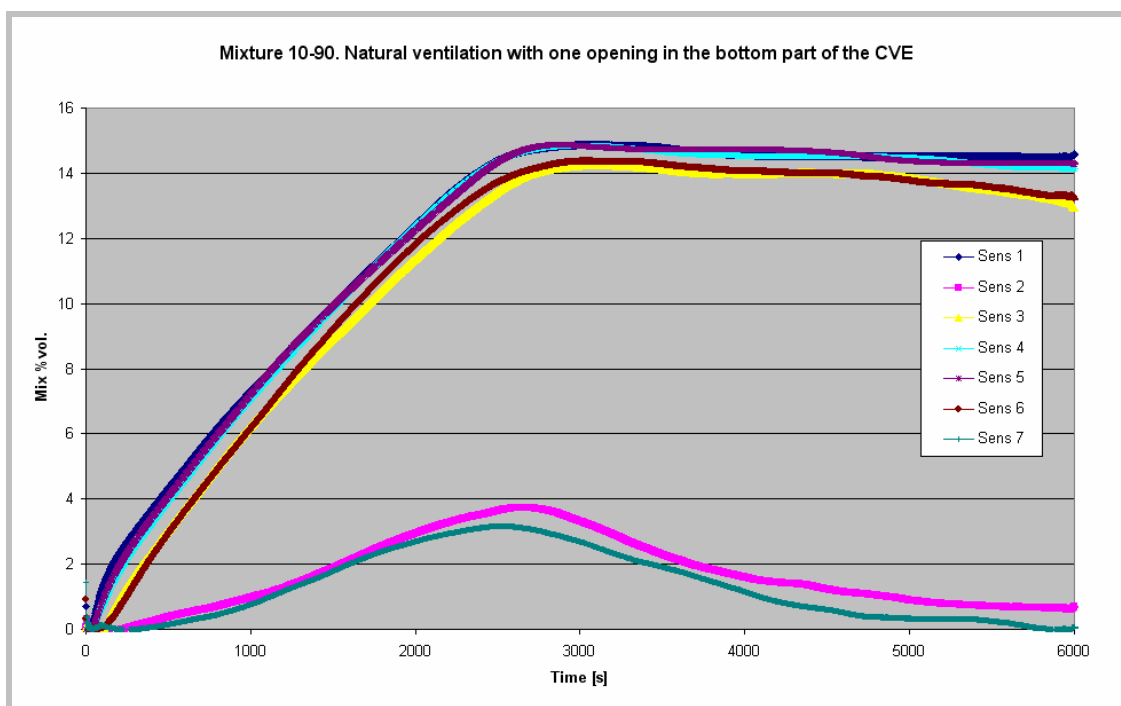

Figure 11 – 04/01/2011 test n.5 Mixture volumetric concentration

In the next figures the data collected with the oxygen sensors (CH₄ Sens) and the gas chromatograph (CH₄ GC) are compared. The graph shows the result only for the methane concentration as the chromatograph was not able to sense the variation of so small volumetric fraction of hydrogen.

The gas chromatograph was used to verify if the basic compounds of the mixture, hydrogen and methane, went through separation and different stratification. The analysis of the data showed that this phenomenon has not occurred for the presented test and the reported mixture residence time within the CVE.

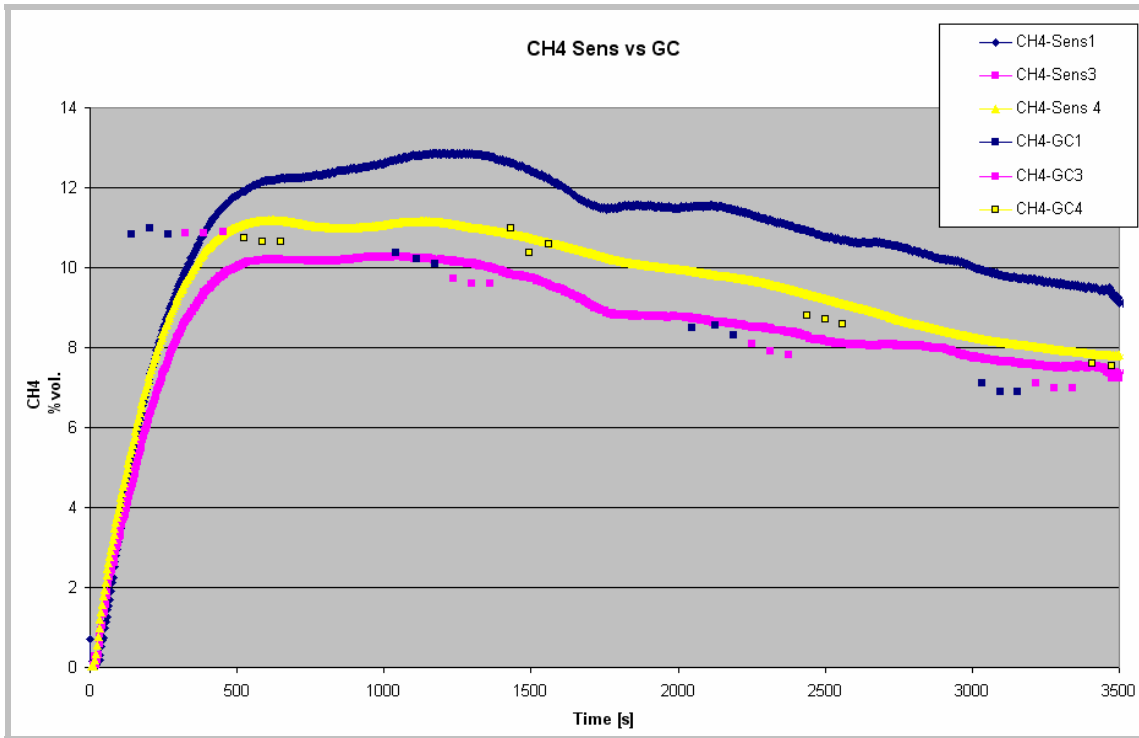

Figure 12 – 29/06/2010 test n.1 Methane volumetric concentration measured by sensors and analysed via gas chromatograph

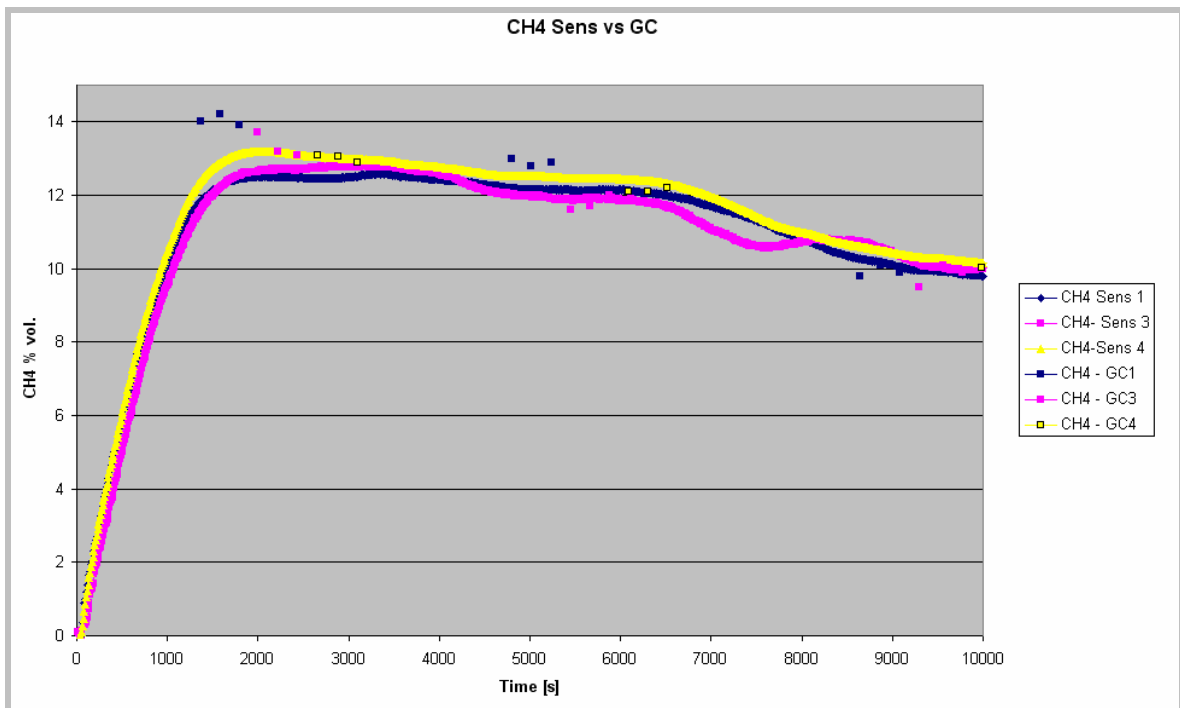

Figure 13 – 13/07/2010 test n.3 Methane volumetric concentration measured by sensors and analysed via gas chromatograph

5.0 CONCLUSIONS

In all the experiments a non homogeneous mixture concentration within the CVE was observed, both with and without natural ventilation and independently of natural ventilation openings position. Moreover for long residence time and no ventilation a tendency to homogenization was also observed as showed in the next figures.

For test carried out with a higher mixture release flow rate, the gas concentration measured at the centre of the ceiling , 2,82 m above the release point, was higher than the concentration measured from sensors located at the same height but not directly above the release. Instead for smaller, release flow rate and no natural ventilation, the concentration within the CVE was well stratified with same values in the horizontal planes.

For test carried out with natural ventilation realized with openings on opposite sides of the CVE (in the upper part on one side and the bottom part in the other side), the gas concentration was not homogeneous in the horizontal planes of the CVE. In fact from Figure 8, it can be noted that the mixture concentration was higher for the sensor 5 and 6, which were the sensor located more distant from the CVE openings (see figure 5). This non uniform gas concentration was due to the air flow through the ventilation openings that created different zones, characterized by different concentration's values, even in the horizontal direction.

For experiments carried out with only one opening located or in the bottom or in the upper part of the CVE, the results were dependent on the difference in temperature between the internal volume of the apparatus and the external ambient air. When the differences in temperature between the internal volume and the outside ambient air were smaller, a stratification was found within the CVE. Instead for higher temperature's differences, the measured gas concentration was not uniform in the horizontal planes of the CVE and the concentration measured by the sensor located in the opposite side, with respect to the opening location, was higher.

In the test carried out with only one opening in the bottom part, it was demonstrated that it was not efficient in diluting the mixture's concentration. Moreover with only one opening in the lower part of the CVE and a difference in temperature, between the internal volume and external ambient air, of about 3°C, the stratification was well evident with homogeneous concentration's values in the horizontal planes of the experimental facility.

Finally, sample analysis with gas chromatograph technique, showed, for the presented experiment configurations and mixture's residence time within the CVE, the non separation between the mixture constituent gases (hydrogen and methane).

6.0 BIBLIOGRAPHY

- [1]: B.J. Lowesmith, et al., *Gas build-up in a domestic property following releases of methane/hydrogen mixtures*, "International Journal of Hydrogen Energy", 34 (2009), 5932-5939.
- [II]: A. Marangon, et al., *Turbulent hydrogen deflagration induced by obstacles in real confined environment*, "International Journal of Hydrogen Energy", 34 (2009), 4669-4674.
- [III]: ISO TC22, SC25, WG5, N003, "*Position Paper blends, Annex*"
- [IV]: www.sensitron.it